

# NEMA 12 WALL MOUNT

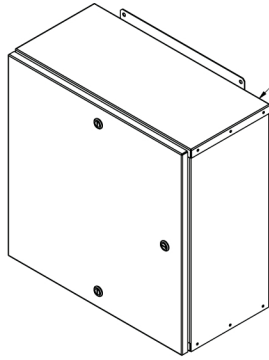

PART NUMBER	H - HEIGHT	W - WIDTH	D - DEPTH	EP - EQUIPMENT PLATE	MH - MOUNTING HEIGHT
24WMN2412	24.00"	24.00"	12.00"	21.00"H x 21.00"W	25.25
18WMN1610	18.00"	16.00"	10.00"	15.00"H x 13.00"W	19.25



RIVETED TOGETHER AND FULLY SEAM WELDED ENCLOSURE

QTY. 3 - DIRAK 200-7026-0430 QUARTER TURN LOCK (OPTIONAL KEY LOCK)

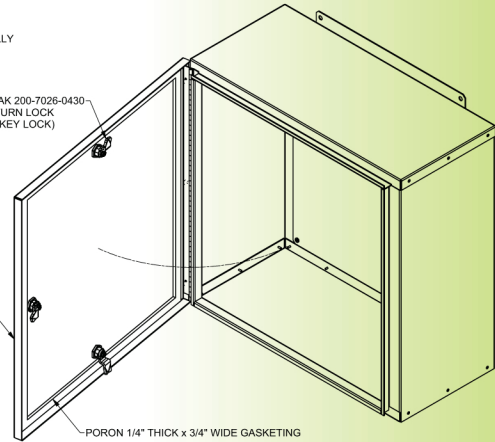

RIVETED ON DOOR ASSEMBLY

PORON 1/4" THICK x 3/4" WIDE GASKETING

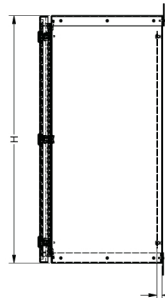
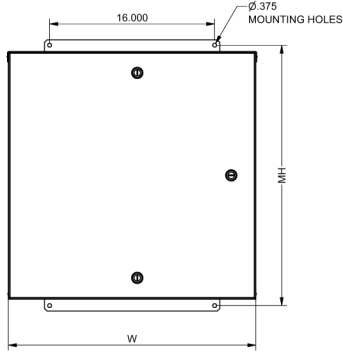

500 OFFSET DISTANCE FROM REAR OF ENCLOSURE TO MOUNTING FACE

QTY. 4 - EQUIPMENT PLATE MOUNTING SCREWS 10-32 x 0.25" L. SCREW

#14 GA C.R.S EQUIPMENT MOUNTING PLATE

### SPECIFICATIONS :

**MOUNTING :** #14 GA EQUIPMENT MOUNTING PLATE

**COLOR :** DURABLE BLACK TEXTURE POWDER COAT.

**RATING :** NEMA-12

**CONSTRUCTION :** #14 C.R.S GAUGE ENCLOSURE MOUNTING PLATES  
#16 C.R.S. GAUGE WELDED BODY & DOOR  
#14 GA C.R.S EQUIPMENT MOUNTING PLATE

# NEMA 12 WALL MOUNT

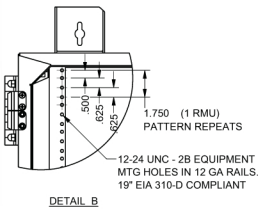

DETAIL B

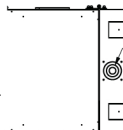

TOP VIEW

REAR TOP CABLE ACCESS FOR 1", 2", 3" CONDUIT SIZES

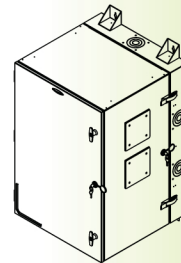

FRONT - ISO

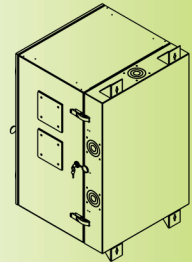

REAR - ISO

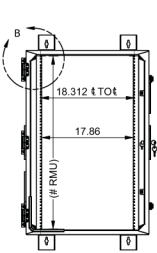

FRONT VIEW w/ DOOR REMOVED

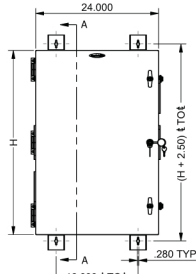

FRONT VIEW

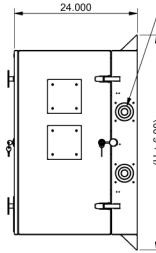

RIGHT SIDE VIEW

SIDE CABLE ACCESS FOR 1", 2", 3" CONDUIT SIZES

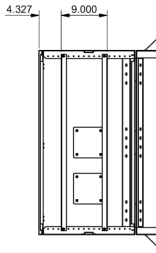

SECTION A-A (RIGHT SIDE VIEW)

Ø1/4" LAG SCREWS RECOMMENDED FOR MOUNTING INTO WALL STUDS

GLAND PLATES CAN BE REMOVED TO ADD OPTIONAL FANS OR FILTERS

HINGED CENTER SECTION OF 14 GA CONSTRUCTION

REAR SECTION OF 14 GA CR.S CONSTRUCTION

### SPECIFICATIONS: NEMA-12 WALL MOUNT

**RATING :** INDEPENDENTLY TESTED & CERTIFIED, NEMA-250-1997 TYPE 12.

**BACK SPACES :** 19" EIA 310-D COMPLIANT - SEE CHART FOR RMU

**COLOR :** DURABLE BLACK TEXTURED POWDER COAT.

**CONSTRUCTION :** #12-24 THREADED MOUNTING RAILS, #12 GA. #14 GA. CENTER BODY, #16 GA. FRONT DOOR, ACCEPTS 1", 2", 3" CONDUIT SIZES FOR CABLE ACCESS. FRONT DOOR & REAR SECTION LOCK INDEPENDENTLY.

PART NUMBER	(H) - HEIGHT	# RMU	WT CAPACIT	SHPG WT
GL240N12	24"	12	150 LBS	105 LBS
GL360N12	36"	19	250 LBS	140 LBS
GL480N12	48"	26	300 LBS	175 LBS

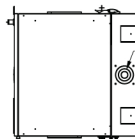

BOTTOM VIEW

SOLID HINGED 16 GA FRONT DOOR w/ (2) DRAW LATCHES PLUS A KEY LOCKING LATCH w/ DUST COVER

REAR BOTTOM CABLE ACCESS FOR 1", 2", 3" CONDUIT SIZES

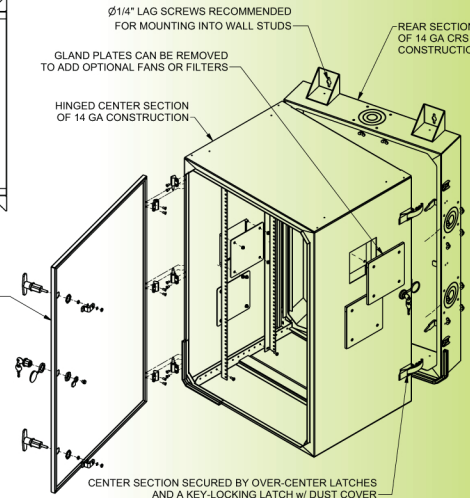

CENTER SECTION SECURED BY OVER-CENTER LATCHES AND A KEY-LOCKING LATCH w/ DUST COVER



Call Rackmount Solutions Ltd at 866-207-6631 or email [sales@rackmountsolutions.net](mailto:sales@rackmountsolutions.net)

TECHNICAL DRAWINGS